



FEATURES

- Low power single 16-bit nanoDAC
- 12-bit accuracy guaranteed
- On-chip 1.25/2.5 V, 10 ppm/°C reference
- Tiny 8-lead SOT-23/MSOP package
- Power-down to 200 nA @ 5 V, 50 nA @ 3 V
- 3 V/5 V single power supply
- Guaranteed 16-bit monotonic by design
- Power-on-reset to zero/midscale
- Three power-down functions
- Serial interface with Schmitt-triggered inputs
- Rail-to-rail operation
- SYNC interrupt facility

APPLICATIONS

- Processcontrol
- Data acquisition systems
- Portable battery-powered instruments
- Digital gain and offset adjustment
- Programmable voltage and current sources
- Programmable attenuators

GENERAL DESCRIPTION

The AD5660 parts are a member of the nanoDAC family of devices. They are low power, single, 16-bit buffered voltage-out DACs, guaranteed monotonic by design.

The AD5660x-1 operate from a 3 V single supply featuring an internal reference of 1.25 V and an internal gain of 2. The AD5660x-2/3 operate from a 5 V single supply featuring an internal reference of 2.5 V and an internal gain of 2. Each reference has a 10 ppm/°C max temperature coefficient. The reference associated with each part is available at the REFOUT pin.

The part incorporates a power-on reset circuit that ensures that the DAC output powers up to 0 V (AD5660x-1/2) or midscale (AD5660x-3) and remains there until a valid write takes place. The part contains a power-down feature that reduces the current consumption of the device to 200 nA at 5 V and provides software selectable output loads while in power-down mode.

The AD5660 uses a versatile three-wire serial interface that operates at clock rates up to 30 MHz and is compatible with standard SPI™, QSPI™, MICROWIRE™ and DSP interface

Rev. Pr J

Information furnished by Analog Devices is believed to be accurate and reliable. However, no responsibility is assumed by Analog Devices for its use, nor for any infringements of patents or other rights of third parties that may result from its use. Specifications subject to change without notice. No license is granted by implication or otherwise under any patent or patent rights of Analog Devices. Trademarks and registered trademarks are the property of their respective owners.

FUNCTIONAL BLOCK DIAGRAM

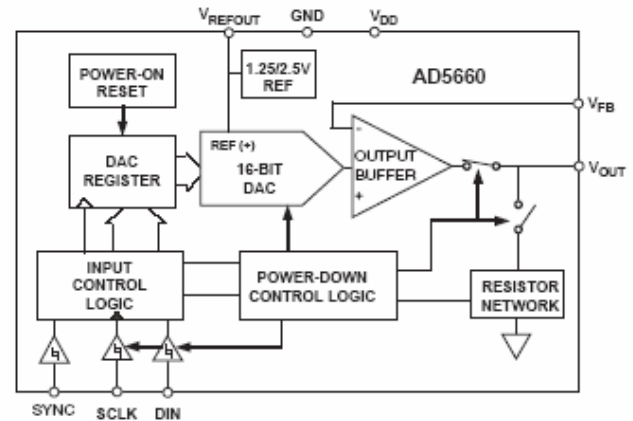

Figure 1.

standards. Its on-chip precision output amplifier allows rail-to-rail output swing to be achieved.

The low power consumption of this part in normal operation makes it ideally suited to portable battery operated equipment. The power consumption is 0.7 mW at 5 V reducing to 1 μW in power-down mode.

The AD5660 is designed with new technology and is the next generation to the AD53xx family.

PRODUCT HIGHLIGHTS

- 16-Bit DAC; 12-Bit Accuracy Guaranteed.
- On-chip 1.25/2.5 V, 10 ppm/°C max Reference.
- Available in 8-lead SOT-23 and 8-lead MSOP package.
- Power-On Reset to 0 V or Midscale.
- Power-down capability. When powered down, the DAC typically consumes 50 nA at 3 V and 200n A at 5 V.
- 10 μS Settling Time.

RELATED DEVICES

Part No.	Description
AD5620/AD5640	3 V/5 V 12-/14-bit DAC with internal ref in SOT-23
AD5662	2.7V to 5.5 V, 16-bit DAC in SOT-23, external reference

TABLE OF CONTENTS

AD5660X-2/3–Specifications	3	Serial Interface	14
AD5660x-1–Specifications	5	$\overline{\text{SYNC}}$ Interrupt	15
Timing Characteristics.....	7	Power-On Reset	15
Pin Configuration and Function Descriptions.....	8	Power-Down Modes	15
Absolute Maximum Ratings.....	9	Microprocessor Interfacing.....	15
ESD Caution.....	9	Applications.....	17
Terminology	10	Using REF19x as a Power Supply for AD5660	17
Typical Performance Characteristics	11	Bipolar Operation Using the AD5660	17
Theory of Operation	14	Using AD5660 with an Opto-Isolated Interface.....	17
D/A Section	14	Power Supply Bypassing and Grounding.....	18
Resistor String	14	Outline Dimensions	19
Output Amplifier	14	Ordering Guide	19

REVISION HISTORY

Revision PrJ: Preliminary

AD5660X-2/3—SPECIFICATIONS

$V_{DD} = 4.5\text{ V to }5.5\text{ V}$; $R_L = 2\text{ k}\Omega$ to GND; $C_L = 200\text{ pF}$ to GND; all specifications T_{MIN} to T_{MAX} , unless otherwise noted.

Table 1.

Parameter	A Grade	B Grade	C Grade	Unit	B Version ¹ Conditions/Comments
STATIC PERFORMANCE²					
Resolution	16	16	16	Bits min	
Relative Accuracy	± 32	± 16	± 16	LSB max	See Figure 4
Differential Nonlinearity	± 1	± 1	± 1	LSB max	Guaranteed Monotonic by Design. See Figure 5.
Zero Code Error	+5	+5	+5	mV typ	All Zeroes Loaded to DAC
	+20	+20	+20	mV max	Register. See Figure 8.
Full-Scale Error	-0.15	-0.15	-0.15	% of FSR typ	All Ones Loaded to DAC
	-1.25	-1.25	-1.25	% of FSR max	Register. See Figure 8
Gain Error	± 1.25	± 1.25	± 1.25	% of FSR max	
Zero Code Error Drift ³	± 20	± 20	± 20	$\mu\text{V}/^\circ\text{C}$ typ	
Gain Temperature Coefficient	± 5	± 5	± 5	ppm typ	f FSR/ $^\circ\text{C}$
OUTPUT CHARACTERISTICS³					
Output Voltage Range	0	0		V min	
	V_{DD}	V_{DD}	V_{DD}	V max	
Output Voltage Settling Time	8	8	8	μs typ	To $\pm 0.003\%$ FSR 0200 _H to FD00 _H
	10	10	10	μs max	$R_L = 2\text{ k}\Omega$; $0\text{ pF} < C_L < 200\text{ pF}$ See Figure 18.
	12	12	12	μs typ	$R_L = 2\text{ k}\Omega$; $C_L = 500\text{ pF}$
Slew Rate	1	1	1	V/ μs typ	
Capacitive Load Stability	470	470	470	pF typ	$R_L = \infty$
	1000	1000	1000	pF typ	$R_L = 2\text{ k}\Omega$
Output Noise	100	100	100	nV/ $\sqrt{\text{Hz}}$ typ	DAC code = 8400 _H , 10 kHz
Output Drift				ppm/ $^\circ\text{C}$ typ	
Digital-to-Analog Glitch Impulse	10	10	10	nV-s typ	1 LSB Change Around Major Carry. See Figure 21.
Digital Feedthrough	0.5	0.5	0.5	nV-s typ	
DC Output Impedance	1	1	1	Ω typ	
Short Circuit Current	50	50	50	mA typ	$V_{DD} = 5\text{ V}$
Power-Up Time	10	10	10	ms typ	Coming Out of Power-Down Mode. $V_{DD} = 5\text{ V}$
REFERENCE OUTPUT					
Output Voltage					
AD5660x-2/3	2.495	2.495	2.495	V min	
	2.505	2.505	2.505	V max	
Reference TC	± 25	± 25	± 10	ppm/ $^\circ\text{C}$ max	
LOGIC INPUTS³					
Input Current	± 1	± 1	± 1	μA max	
V_{INL} , Input Low Voltage	0.8	0.8	0.8	V max	$V_{DD} = 5\text{ V}$
V_{INH} , Input High Voltage	2	2	2	V min	$V_{DD} = 5\text{ V}$
Pin Capacitance	3	3	3	pF max	

Parameter	A Grade	B Grade	C Grade	Unit	B Version ¹ Conditions/Comments
POWER REQUIREMENTS					
V_{DD}	4.5	4.5	4.5	V min	All Digital Inputs at 0 V or V_{DD}
	5.5	5.5	5.5	V max	DAC Active and Excluding Load Current
I_{DD} (Normal Mode) $V_{DD} = 4.5 \text{ V to } +5.5 \text{ V}$	0.5	0.5	0.5	mA typ	$V_{IH} = V_{DD}$ and $V_{IL} = \text{GND}$
$V_{DD} = 4.5 \text{ V to } +5.5 \text{ V}$ I_{DD} (All Power-Down Modes)	1	1	1	mA max	$V_{IH} = V_{DD}$ and $V_{IL} = \text{GND}$
$V_{DD} = 4.5 \text{ V to } +5.5 \text{ V}$	0.2	0.2	0.2	$\mu\text{A typ}$	$V_{IH} = V_{DD}$ and $V_{IL} = \text{GND}$
$V_{DD} = 4.5 \text{ V to } +5.5 \text{ V}$	1	1	1	$\mu\text{A max}$	$V_{IH} = V_{DD}$ and $V_{IL} = \text{GND}$
POWER EFFICIENCY					
I_{OUT}/I_{DD}	89	89	89	%	$I_{LOAD} = 2 \text{ mA}, V_{DD} = 5 \text{ V}$

¹ Temperature ranges are as follows: B Version: -40°C to +105°C, typical at 25°C.

² Linearity calculated using a reduced code range of 485 to 64714. Output unloaded.

³ Guaranteed by design and characterization, not production tested.

AD5660X-1—SPECIFICATIONS

$V_{DD} = 2.7\text{ V to }3.6\text{ V}$; $R_L = 2\text{ k}\Omega$ to GND; $C_L = 200\text{ pF}$ to GND; all specifications T_{MIN} to T_{MAX} , unless otherwise noted.

Table 2.

Parameter	A Grade	B Grade	C Grade	Unit	B Version ⁴ Conditions/Comments
STATIC PERFORMANCE⁵					
Resolution	16	16	16	Bits min	
Relative Accuracy	± 32	± 16	± 16	LSB max	See Figure 4
Differential Nonlinearity	± 1	± 1	± 1	LSB max	Guaranteed Monotonic by Design. See Figure 5.
Zero Code Error	+5	+5	+5	mV typ	All Zeroes Loaded to DAC
	+20	+20	+20	mV max	Register. See Figure 8.
Full-Scale Error	-0.15	-0.15	-0.15	% of FSR typ	All Ones Loaded to DAC
	-1.25	-1.25	-1.25	% of FSR max	Register. See Figure 8.
Gain Error	± 1.25	± 1.25	± 1.25	% of FSR max	
Zero Code Error Drift ⁶	± 20	± 20	± 20	$\mu\text{V}/^\circ\text{C}$ typ	
Gain Temperature Coefficient	± 5	± 5	± 5	ppm typ	of FSR/ $^\circ\text{C}$
OUTPUT CHARACTERISTICS³					
Output Voltage Range	0	0		V min	
	V_{DD}	V_{DD}	V_{DD}	V max	
Output Voltage Settling Time	8	8	8	μs typ	To $\pm 0.003\%$ FSR 0200 _H to FD00 _H
	10	10	10	μs max	$R_L = 2\text{ k}\Omega$; $0\text{ pF} < C_L < 200\text{ pF}$ See Figure 18.
	12	12	12	μs typ	$R_L = 2\text{ k}\Omega$; $C_L = 500\text{ pF}$
Slew Rate	1	1	1	V/ μs typ	
Capacitive Load Stability	470	470	470	pF typ	$R_L = \infty$
	1000	1000	1000	pF typ	$R_L = 2\text{ k}\Omega$
Output Noise	100	100	100	nV/ $\sqrt{\text{Hz}}$ typ	DAC code = 8400 _H , 10 kHz
Output Drift		tbd		ppm/ $^\circ\text{C}$ typ	
Digital-to-Analog Glitch Impulse	10	10	10	nV-s typ	1 LSB Change Around Major Carry. See Figure 21.
Digital Feedthrough	0.5	0.5	0.5	nV-s typ	
DC Output Impedance	1	1	1	Ω typ	
Short Circuit Current	20	20	20	mA typ	$V_{DD} = 3\text{ V}$
Power-Up Time	10	10	10	ms typ	Coming Out of Power-Down Mode. $V_{DD} = 3\text{ V}$
REFERENCE OUTPUT					
Output Voltage					
AD5660x-1	1.248	1.248	1.248	V min	
	1.252	1.252	1.252	V max	
Reference TC	± 25	± 25	± 10	ppm/ $^\circ\text{C}$ max	
LOGIC INPUTS³					
Input Current	± 1	± 1	± 1	μA max	
V_{INL} , Input Low Voltage	0.8	0.8	0.8	V max	$V_{DD} = 3\text{ V}$
V_{INH} , Input High Voltage	2	2	2	V min	$V_{DD} = 3\text{ V}$
Pin Capacitance	3	3	3	pF max	

Parameter	A Grade	B Grade	C Grade	Unit	B Version ⁴ Conditions/Comments
POWER REQUIREMENTS					
V_{DD}	2.7	2.7	2.7	V min	All Digital Inputs at 0 V or V_{DD} DAC Active and Excluding Load Current
	3.6	3.6	3.6	V max	
I_{DD} (Normal Mode)					
$V_{DD} = 2.7\text{ V to }3.6\text{ V}$	0.5	0.5	0.5	mA typ	$V_{IH} = V_{DD}$ and $V_{IL} = \text{GND}$
$V_{DD} = 2.7\text{ V to }3.6\text{ V}$	1	1	1	mA max	$V_{IH} = V_{DD}$ and $V_{IL} = \text{GND}$
I_{DD} (All Power-Down Modes)					
$V_{DD} = 2.7\text{ V to }3.6\text{ V}$	0.2	0.2	0.2	$\mu\text{A typ}$	$V_{IH} = V_{DD}$ and $V_{IL} = \text{GND}$
$V_{DD} = 2.7\text{ V to }3.6\text{ V}$	1	1	1	$\mu\text{A max}$	$V_{IH} = V_{DD}$ and $V_{IL} = \text{GND}$
POWER EFFICIENCY					
I_{OUT}/I_{DD}					$I_{LOAD} = 2\text{ mA}, V_{DD} = 3\text{ V}$

⁴ Temperature ranges are as follows: B Version: -40°C to +105°C, typical at 25°C.

⁵ Linearity calculated using a reduced code range of 485 to 64714. Output unloaded.

⁶ Guaranteed by design and characterization, not production tested.

TIMING CHARACTERISTICS

All input signals are specified with $t_r = t_f = 1 \text{ ns/V}$ (10% to 90% of V_{DD}) and timed from a voltage level of $(V_{IL} + V_{IH})/2$. See Figure 2.

$V_{DD} = 2.7 \text{ V}$ to 5.5 V ; all specifications T_{MIN} to T_{MAX} , unless otherwise noted.

Parameter	Limit at T_{MIN}, T_{MAX}		Unit	Conditions/Comments
	$V_{DD} = 2.7 \text{ V to } 3.6 \text{ V}$	$V_{DD} = 3.6 \text{ V to } 5.5 \text{ V}$		
t_1^1	50	33	ns min	SCLK Cycle Time
t_2	13	13	ns min	SCLK High Time
t_3	13	13	ns min	SCLK Low Time
t_4	13	13	ns min	$\overline{\text{SYNC}}$ to SCLK Falling Edge Setup Time
t_5	5	5	ns min	Data Setup Time
t_6	4.5	4.5	ns min	Data Hold Time
t_7	0	0	ns min	SCLK Falling Edge to $\overline{\text{SYNC}}$ Rising Edge
t_8	50	33	ns min	Minimum $\overline{\text{SYNC}}$ High Time
t_9	13	13	ns min	$\overline{\text{SYNC}}$ Rising Edge to SCLK Fall Ignore
t_{10}	0	0	ns min	SCLK Falling Edge to $\overline{\text{SYNC}}$ Fall Ignore

¹ Maximum SCLK frequency is 30 MHz at $V_{DD} = 3.6 \text{ V}$ to 5.5 V and 20 MHz at $V_{DD} = 2.7 \text{ V}$ to 3.6 V .

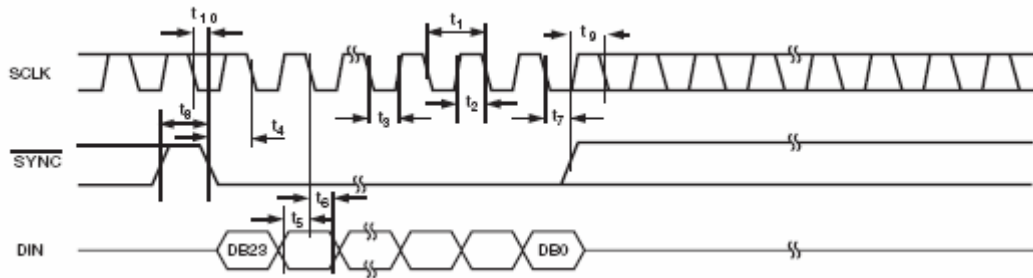

Figure 2. Serial Write Operation

PIN CONFIGURATION AND FUNCTION DESCRIPTIONS

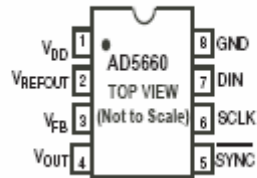

Figure 3. Pin Configuration

Table 3. Pin Function Descriptions

Pin No.	Mnemonic	Function
1	V_{DD}	Power Supply Input. These parts can be operated from 2.5 V to 5.5 V and V_{DD} should be decoupled to GND.
2	V_{REFOUT}	Reference Voltage Output.
3	V_{FB}	Feedback connection for the output amplifier.
4	V_{OUT}	Analog output voltage from DAC. The output amplifier has rail to rail operation.
5	\overline{SYNC}	Level triggered control input (active low). This is the frame synchronization signal for the input data. When \overline{SYNC} goes low, it enables the input shift register and data is transferred in on the falling edges of the following clocks. The DAC is updated following the 24th clock cycle unless \overline{SYNC} is taken high before this edge in which case the rising edge of \overline{SYNC} acts as an interrupt and the write sequence is ignored by the DAC.
6	SCLK	Serial Clock Input. Data is clocked into the input shift register on the falling edge of the serial clock input. Data can be transferred at rates up to 30 MHz.
7	D_{IN}	Serial Data Input. This device has a 24-bit shift register. Data is clocked into the register on the falling edge of the serial clock input.
8	GND	Ground reference point for all circuitry on the part.

ABSOLUTE MAXIMUM RATINGS

$T_A = +25^\circ\text{C}$ unless otherwise noted.

Table 4.

Parameter	Rating
V_{DD} to GND	-0.3 V to +7 V
Digital Input Voltage to GND	-0.3 V to $V_{DD} + 0.3$ V
V_{OUT} to GND	-0.3 V to $V_{DD} + 0.3$ V
Operating Temperature Range	
Industrial (B Version)	-40°C to +105°C
Storage Temperature Range	-65°C to +150°C
Junction Temperature (T_J max)	150°C
SOT-23 Package	
Power Dissipation	$(T_J \text{ max} - T_A)/\theta_{JA}$
θ_{JA} Thermal Impedance	240°C/W
Lead Temperature, Soldering	
Vapor Phase (60 sec)	215°C
Infrared (15 sec)	220°C

Stresses above those listed under Absolute Maximum Ratings may cause permanent damage to the device. This is a stress rating only; functional operation of the device at these or any other conditions above those listed in the operational sections of this specification is not implied. Exposure to absolute maximum rating conditions for extended periods may affect device reliability.

ESD CAUTION

ESD (electrostatic discharge) sensitive device. Electrostatic charges as high as 4000 V readily accumulate on the human body and test equipment and can discharge without detection. Although this product features proprietary ESD protection circuitry, permanent damage may occur on devices subjected to high energy electrostatic discharges. Therefore, proper ESD precautions are recommended to avoid performance degradation or loss of functionality.



TERMINOLOGY

Relative Accuracy

For the DAC, relative accuracy or Integral Nonlinearity (INL) is a measure of the maximum deviation, in LSBs, from a straight line passing through the endpoints of the DAC transfer function. A typical INL vs. code plot can be seen in Figure 4.

Differential Nonlinearity

Differential Nonlinearity (DNL) is the difference between the measured change and the ideal 1 LSB change between any two adjacent codes. A specified differential nonlinearity of ± 1 LSB maximum ensures monotonicity. This DAC is guaranteed monotonic by design. A typical DNL vs. code plot can be seen in Figure 5.

Zero-Code Error

Zero-code error is a measure of the output error when zero code (0000Hex) is loaded to the DAC register. Ideally the output should be 0 V. The zero-code error is always positive in the AD5660 because the output of the DAC cannot go below 0 V. It is due to a combination of the offset errors in the DAC and output amplifier. Zero-code error is expressed in mV. A plot of zero-code error vs. temperature can be seen in Figure 8.

Full-Scale Error

Full-scale error is a measure of the output error when full-scale code (FFFF Hex) is loaded to the DAC register. Ideally the output should be $V_{DD} - 1$ LSB. Full-scale error is expressed in percent of full-scale range. A plot of full-scale error vs. temperature can be seen in Figure 8.

Gain Error

This is a measure of the span error of the DAC. It is the deviation in slope of the DAC transfer characteristic from ideal expressed as a percent of the full-scale range.

Total Unadjusted Error

Total Unadjusted Error (TUE) is a measure of the output error taking all the various errors into account. A typical TUE vs. code plot can be seen in Figure 6.

Zero-Code Error Drift

This is a measure of the change in zero-code error with a change in temperature. It is expressed in $\mu\text{V}/^\circ\text{C}$.

Gain Error Drift

This is a measure of the change in gain error with changes in temperature. It is expressed in (ppm of full-scale range)/ $^\circ\text{C}$.

Digital-to-Analog Glitch Impulse

Digital-to-analog glitch impulse is the impulse injected into the analog output when the input code in the DAC register changes state. It is normally specified as the area of the glitch in nV secs and is measured when the digital input code is changed by 1 LSB at the major carry transition (7FFF Hex to 8000 Hex). See Figure 21.

Digital Feedthrough

Digital feedthrough is a measure of the impulse injected into the analog output of the DAC from the digital inputs of the DAC but is measured when the DAC output is not updated. It is specified in nV secs and measured with a full-scale code change on the data bus, i.e., from all 0s to all 1s and vice versa.

TYPICAL PERFORMANCE CHARACTERISTICS

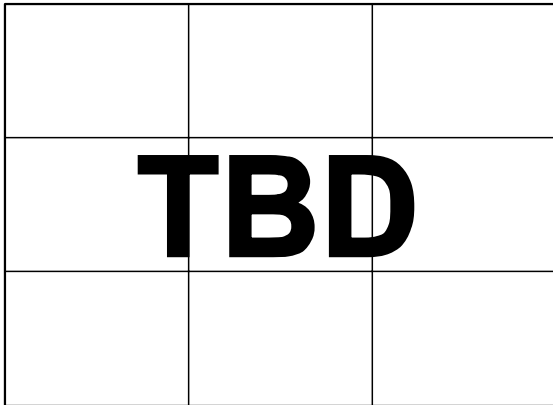

Figure 4. Typical INL Plot

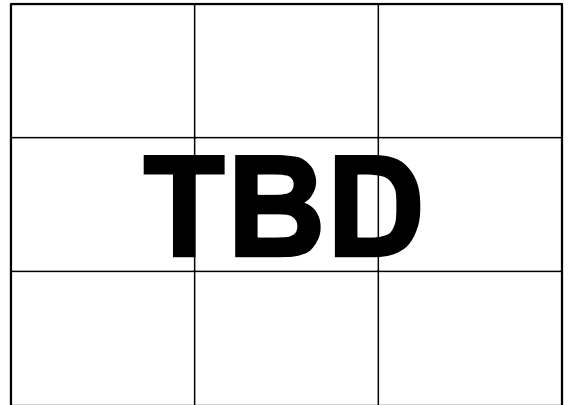

Figure 7. INL Error and DNL Error vs. Temperature

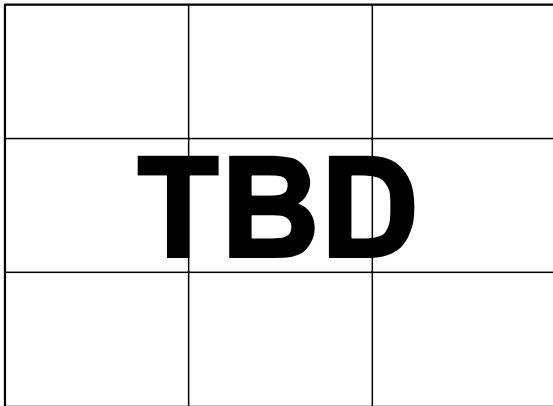

Figure 5. Typical DNL Plot

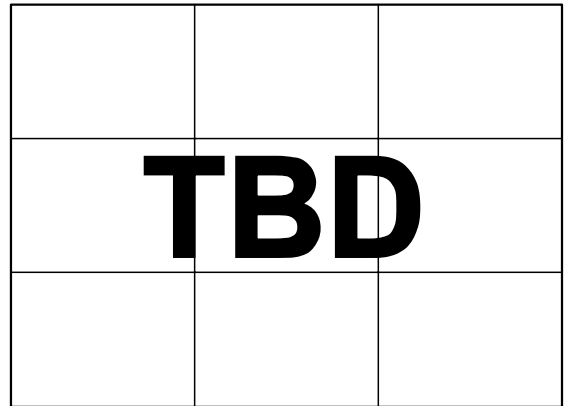

Figure 8. Zero-Scale Error and Full-Scale Error vs. Temperature

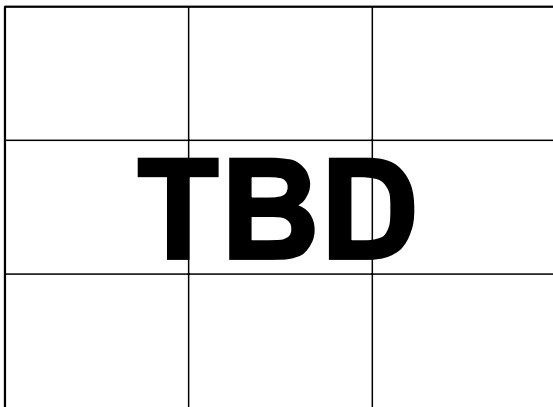

Figure 6. Typical Total Unadjusted Error Plot

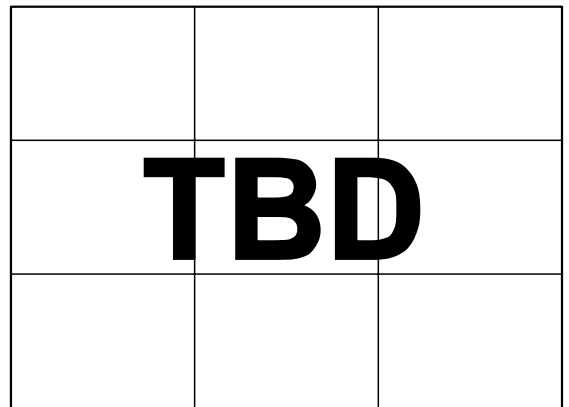

Figure 9. I_{DD} Histogram with $V_{DD} = 3\text{ V}$ and $V_{DD} = 5\text{ V}$

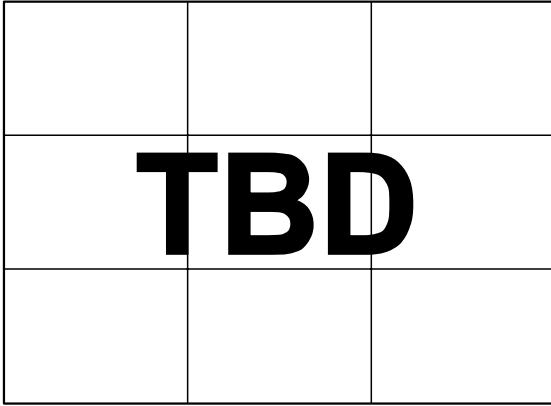

Figure 10. Source and Sink Current Capability with $V_{DD} = 3\text{ V}$

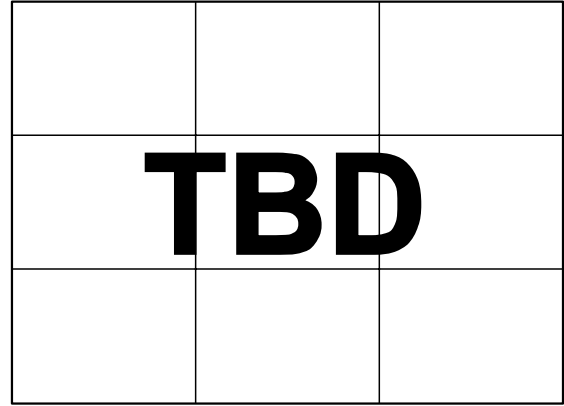

Figure 13. Supply Current vs. Temperature

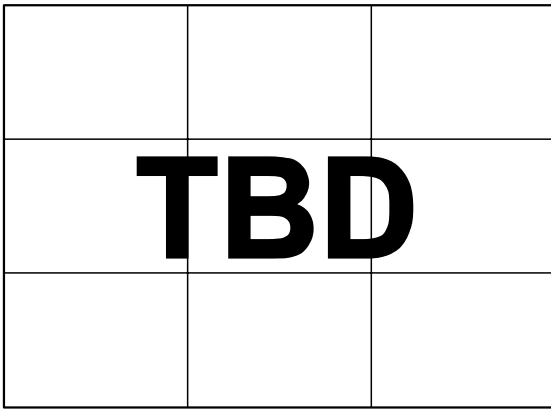

Figure 11. Source and Sink Current Capability with $V_{DD} = 5\text{ V}$

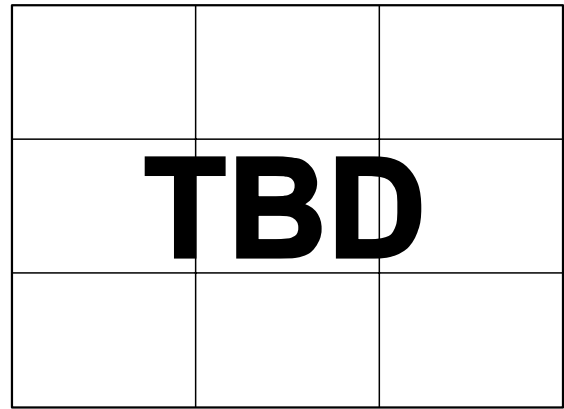

Figure 14. Supply Current vs. Supply Voltage

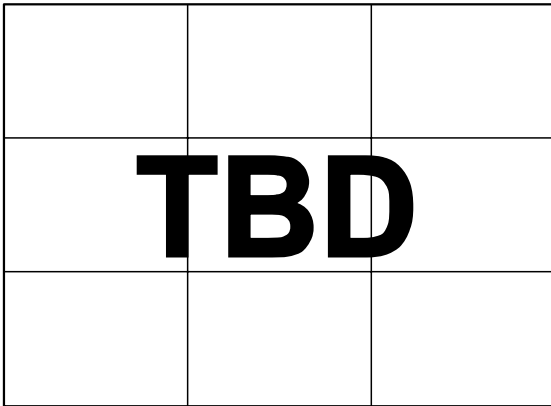

Figure 12. Supply Current vs. Code

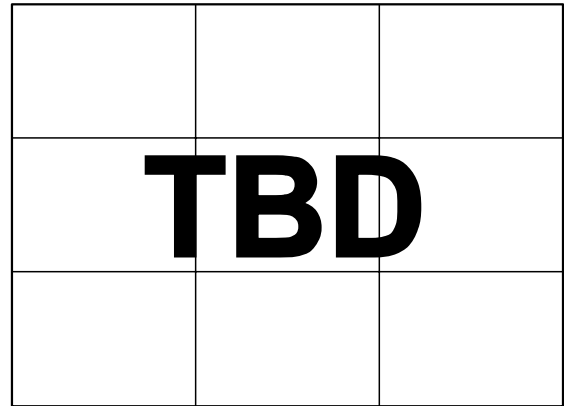

Figure 15. Power-Down Current vs. Supply Voltage

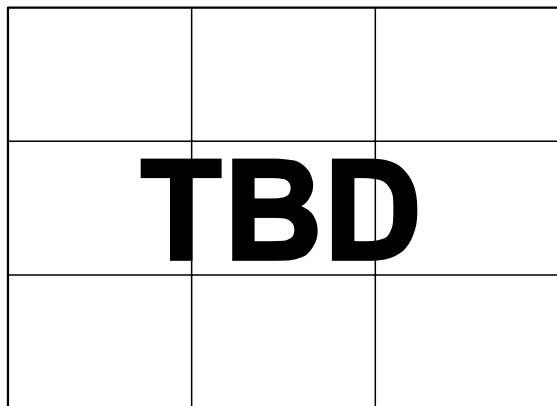

Figure 16. Supply Current vs. Logic Input Voltage

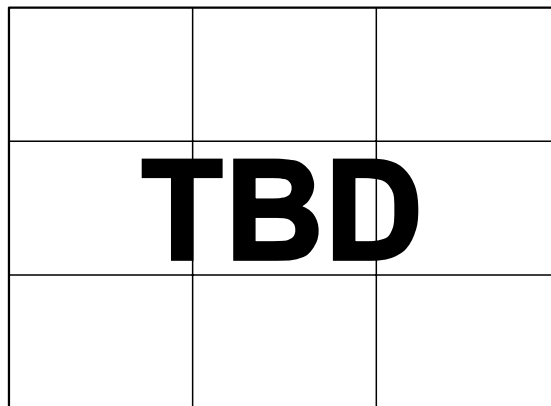

Figure 19. Power-On Reset to 0V

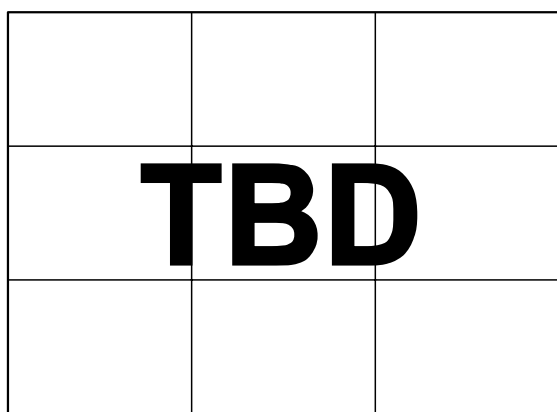

Figure 17. Full-Scale Settling Time

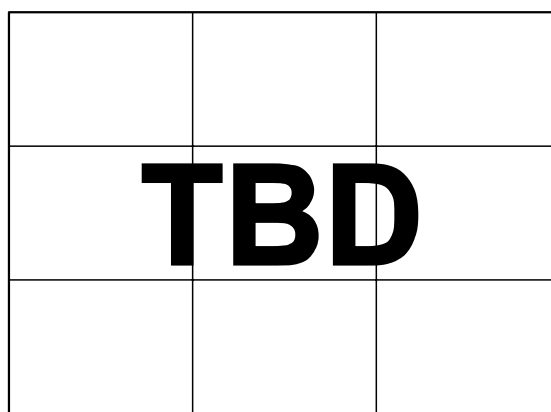

Figure 20. Exiting Power-Down (800 Hex Loaded)

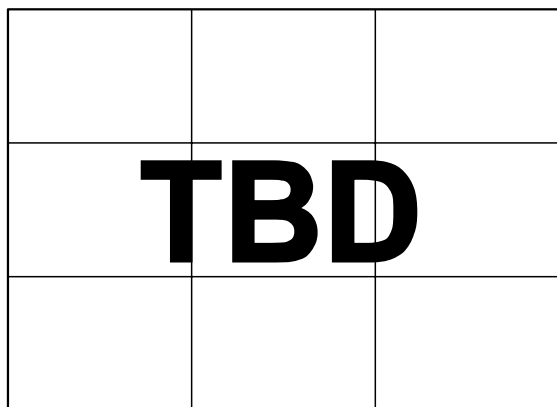

Figure 18. Half-Scale Settling Time

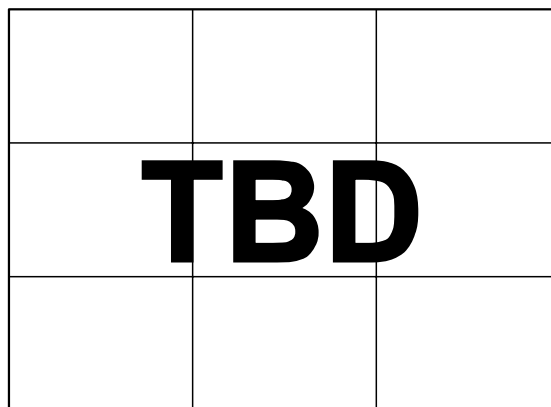

Figure 21. Digital-to-Analog Glitch Impulse

THEORY OF OPERATION

D/A SECTION

The AD5660 DAC is fabricated on a CMOS process. The architecture consists of a string DAC followed by an output buffer amplifier. The parts include an internal 1.25 V/2.5 V, 10 ppm/°C reference with an internal gain of two. Figure 22 shows a block diagram of the DAC architecture.

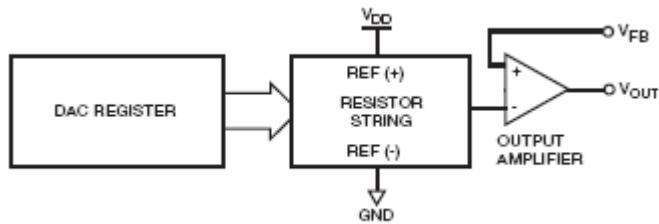

Figure 22. DAC Architecture

Since the input coding to the DAC is straight binary, the ideal output voltage is given by:

$$V_{OUT} = 2xVREF \times \left(\frac{D}{65536} \right)$$

where D = the decimal equivalent of the binary code that is loaded to the DAC register; it can range from 0 to 65535.

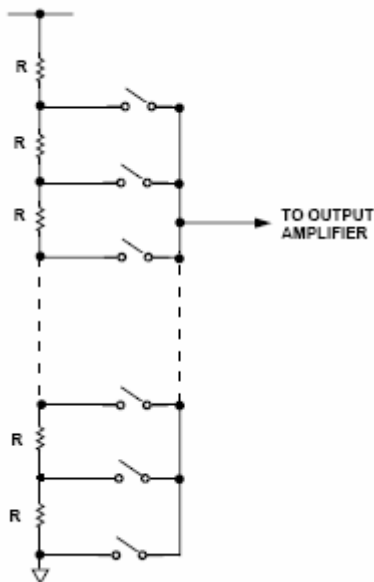

Figure 23. Resistor String

RESISTOR STRING

The resistor string section is shown in Figure 23. It is simply a string of resistors, each of value R . The code loaded to the DAC register determines at which node on the string the voltage is tapped off to be fed into the output amplifier. The voltage is tapped off by closing one of the switches connecting the string to the amplifier. Because it is a string of resistors, it is guaranteed monotonic.

OUTPUT AMPLIFIER

The output buffer amplifier is capable of generating rail-to-rail voltages on its output which gives an output range of 0 V to V_{DD} . It is capable of driving a load of 2 k Ω in parallel with 1000 pF to GND. The source and sink capabilities of the output amplifier can be seen in Figure 10 and Figure 11. The slew rate is 1 V/ μ s with a half-scale settling time of 8 μ s with the output unloaded.

SERIAL INTERFACE

The AD5660 has a 3-wire serial interface ($\overline{\text{SYNC}}$, SCLK and DIN), which is compatible with SPI, QSPI and MICROWIRE interface standards as well as most DSPs. See Figure 2 for a timing diagram of a typical write sequence.

The write sequence begins by bringing the $\overline{\text{SYNC}}$ line low. Data from the DIN line is clocked into the 24-bit shift register on the falling edge of SCLK. The serial clock frequency can be as high as 30 MHz, making the AD5660 compatible with high speed DSPs. On the 24th falling clock edge, the last data bit is clocked in and the programmed function is executed, that is, a change in DAC register contents and/or a change in the mode of operation. At this stage, the $\overline{\text{SYNC}}$ line may be kept low or be brought high. In either case, it must be brought high for a minimum of 33 ns before the next write sequence so that a falling edge of $\overline{\text{SYNC}}$ can initiate the next write sequence. Since the $\overline{\text{SYNC}}$ buffer draws more current when $V_{IN} = 2.4$ V than it does when $V_{IN} = 0.8$ V, $\overline{\text{SYNC}}$ should be idled low between write sequences for even lower power operation of the part. As is mentioned above, however, it must be brought high again just before the next write sequence.

INPUT SHIFT REGISTER

The input shift register is 24 bits wide (see Figure 24). The first six bits are “don’t cares.” The next two are control bits that control which mode of operation the part is in (normal mode or any one of three power-down modes). There is a more complete description of the various modes in the Power-Down Modes section. The next sixteen bits are the data bits. These are transferred to the DAC register on the 24th falling edge of SCLK.

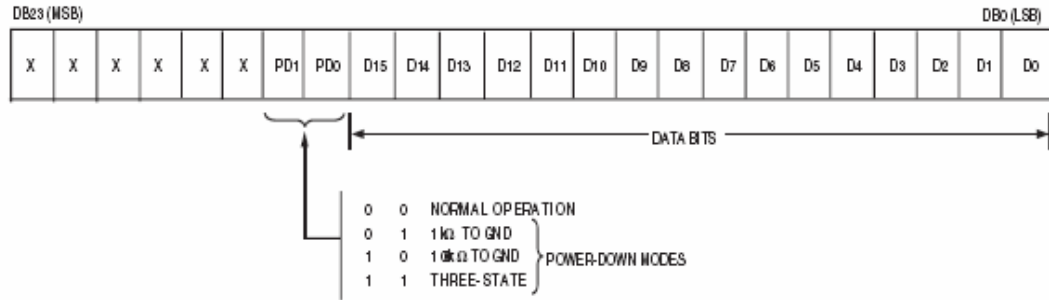

Figure 24. Input Register Contents

SYNC INTERRUPT

In a normal write sequence, the SYNC line is kept low for at least 24 falling edges of SCLK and the DAC is updated on the 24th falling edge. However, if SYNC is brought high before the 24th falling edge this acts as an interrupt to the write sequence. The shift register is reset and the write sequence is seen as invalid. Neither an update of the DAC register contents or a change in the operating mode occurs—see Figure 27.

POWER-ON RESET

The AD5660 family contains a power-on reset circuit that controls the output voltage during power-up. The AD5660x-1/2 DAC output powers up to zero volts and the AD5660x-3 DAC output powers up to midscale. The output remains there until a valid write sequence is made to the DAC. This is useful in applications where it is important to know the state of the output of the DAC while it is in the process of powering up.

POWER-DOWN MODES

The AD5660 contains four separate modes of operation. These modes are software-programmable by setting two bits (DB17 and DB16) in the control register. Table 5 shows how the state of the bits corresponds to the mode of operation of the device.

Table 5. Modes of Operation for the AD5660

DB17	DB16	Operating Mode
0	0	Normal Operation
0	1	Power Down Modes
1	0	1 kΩ to GND
1	0	100 kΩ to GND
1	1	Three State

When both bits are set to 0, the part works normally with its normal power consumption of 250 μA at 5 V. However, for the three power-down modes, the supply current falls to 200 nA at 5 V (50 nA at 3 V). Not only does the supply current fall but the output stage is also internally switched from the output of the amplifier to a resistor network of known values. This has the advantage that the output impedance of the part is known while the part is in power-down mode. There are three different

options. The output is connected internally to GND through a 1 kΩ resistor, a 100 kΩ resistor or it is left open-circuited (Three-State). The output stage is illustrated in Figure 25.

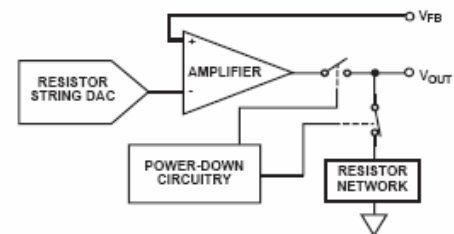

Figure 25. Output Stage During Power-Down

The bias generator, the output amplifier, the resistor string and other associated linear circuitry are all shut down when the power-down mode is activated. However, the contents of the DAC register are unaffected when in power-down. The time to exit power-down is typically 2.5 μs for V_{DD} = 5 V and 5 μs for V_{DD} = 3 V. See Figure 20 for a plot.

**MICROPROCESSOR INTERFACING
AD5660 to ADSP-2101/ADSP-2103 Interface**

Figure 26 shows a serial interface between the AD5660 and the ADSP-2101/ADSP-2103. The ADSP-2101/ADSP-2103 should be set up to operate in the SPORT transmit alternate framing mode. The ADSP-2101/ADSP-2103 SPORT is programmed through the SPORT control register and should be configured as follows: internal clock operation, active low framing, 24-bit word length. Transmission is initiated by writing a word to the Tx register after the SPORT has been enabled.

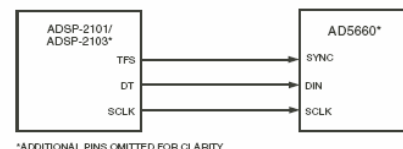

Figure 26. AD5660 to ADSP-2101/ADSP-2103 Interface

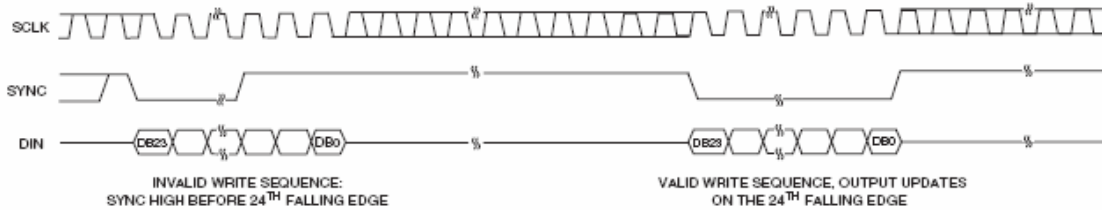

Figure 27. SYNC Interrupt Facility

AD5660 to 68HC11/68L11 Interface

Figure 28 shows a serial interface between the AD5660 and the 68HC11/68L11 microcontroller. SCK of the 68HC11/68L11 drives the SCLK of the AD5660, while the MOSI output drives the serial data line of the DAC. The SYNC signal is derived from a port line (PC7). The setup conditions for correct operation of this interface are as follows: the 68HC11/68L11 should be configured so that its CPOL bit is a 0 and its CPHA bit is a 1. When data is being transmitted to the DAC, the SYNC line is taken low (PC7). When the 68HC11/68L11 is configured as above, data appearing on the MOSI output is valid on the falling edge of SCK. Serial data from the 68HC11/68L11 is transmitted in 8-bit bytes with only eight falling clock edges occurring in the transmit cycle. Data is transmitted MSB first. In order to load data to the AD5660, PC7 is left low after the first eight bits are transferred, and a second serial write operation is performed to the DAC and PC7 is taken high at the end of this procedure.

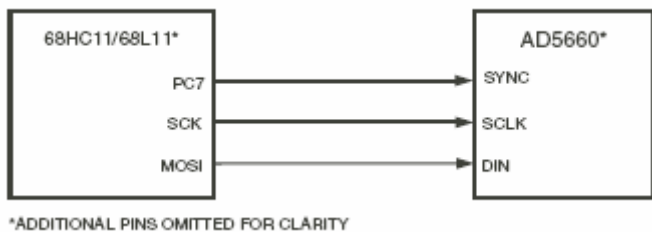

Figure 28. AD5660 to 68HC11/68L11 Interface

AD5660 to 80C51/80L51 Interface

Figure 29 shows a serial interface between the AD5660 and the 80C51/80L51 microcontroller. The setup for the interface is as follows: TXD of the 80C51/80L51 drives SCLK of the AD5660, while RXD drives the serial data line of the part. The SYNC signal is again derived from a bit programmable pin on the port. In this case port line P3.3 is used. When data is to be transmitted to the AD5660, P3.3 is taken low. The 80C51/80L51 transmits data only in 8-bit bytes; thus only eight falling clock edges occur in the transmit cycle. To load data to the DAC, P3.3 is left low after the first eight bits are transmitted, and a second write cycle is initiated to transmit the second byte of data. P3.3 is taken high following the completion of this cycle. The

80C51/80L51 outputs the serial data in a format which has the LSB first. The AD5660 requires its data with the MSB as the first bit received. The 80C51/80L51 transmit routine should take this into account.

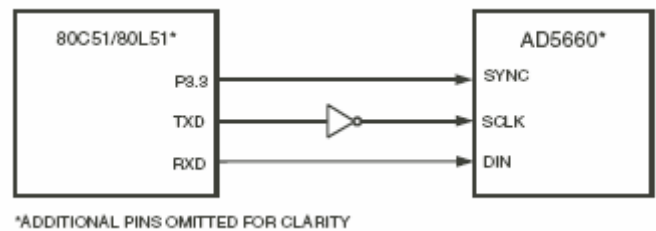

Figure 29. AD5660 to 80C51 Interface

AD5660 to MICROWIRE Interface

Figure 30 shows an interface between the AD5320 and any MICROWIRE compatible device. Serial data is shifted out on the falling edge of the serial clock and is clocked into the AD5320 on the rising edge of the SK.

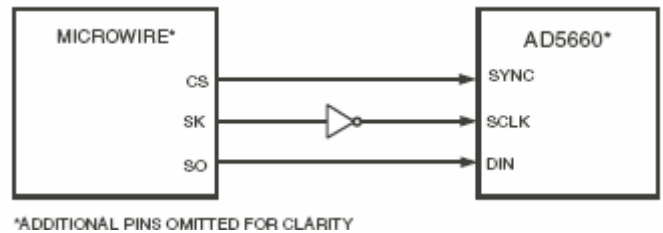

Figure 30. AD5660 to MICROWIRE Interface

APPLICATIONS

USING REF19X AS A POWER SUPPLY FOR AD5660

Because the supply current required by the AD5660 is extremely low, an alternative option is to use a REF19x voltage reference (REF195 for 5 V or REF193 for 3 V) to supply the required voltage to the part—see Figure 31. This is especially useful if the power supply is quite noisy or if the system supply voltages are at some value other than 5 V or 3 V, for example, 15 V. The REF19x will output a steady supply voltage for the AD5660. If the low dropout REF195 is used, the current it needs to supply to the AD5660 is 250 μ A. This is with no load on the output of the DAC. When the DAC output is loaded, the REF195 also needs to supply the current to the load. The total current required (with a 5 k Ω load on the DAC output) is

$$250 \mu A + (5 \text{ V} / 5 \text{ k}\Omega) = 1.25 \text{ mA}$$

The load regulation of the REF195 is typically 2 ppm/mA, which results in an error of 2.5 ppm (12.5 μ V) for the 1.25 mA current drawn from it. This corresponds to a 0.164 LSB error.

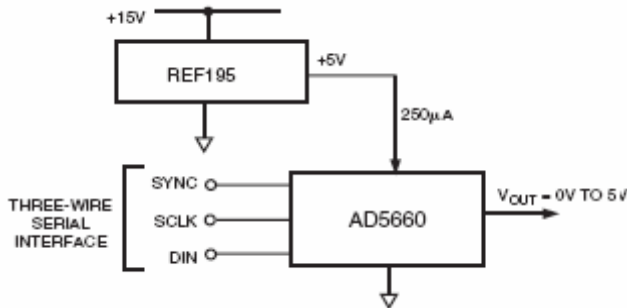

Figure 31. REF195 as Power Supply to AD5660

BIPOLAR OPERATION USING THE AD5660

The AD5660 has been designed for single-supply operation but a bipolar output range is also possible using the circuit in Figure 32. The circuit below will give an output voltage range of ± 5 V. Rail-to-rail operation at the amplifier output is achievable using an AD820 or an OP295 as the output amplifier.

The output voltage for any input code can be calculated as follows:

$$V_O = \left[V_{DD} \times \left(\frac{D}{65536} \right) \times \left(\frac{R1 + R2}{R1} \right) - V_{DD} \times \left(\frac{R2}{R1} \right) \right]$$

where D represents the input code in decimal (0–65535). With $V_{DD} = 5$ V, $R1 = R2 = 10$ k Ω :

$$V_O = \left(\frac{10 \times D}{65536} \right) - 5 \text{ V}$$

This is an output voltage range of ± 5 V with 0000Hex corresponding to a -5 V output and FFFF Hex corresponding to a $+5$ V output.

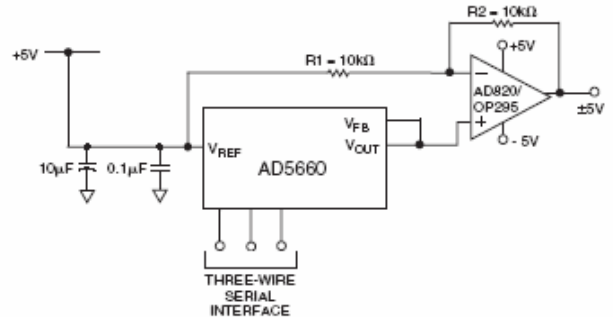

Figure 32. Bipolar Operation with the AD5660

USING AD5660 WITH AN OPTO-ISOLATED INTERFACE

In process-control applications in industrial environments it is often necessary to use an opto-isolated interface to protect and isolate the controlling circuitry from any hazardous common-mode voltages that may occur in the area where the DAC is functioning. Opto-isolators provide isolation in excess of 3 kV. Because the AD5660 uses a three-wire serial logic interface, it requires only three opto-isolators to provide the required isolation (see Figure 33). The power supply to the part also needs to be isolated. This is done by using a transformer. On the DAC side of the transformer, a 5 V regulator provides the 5 V supply required for the AD5660.

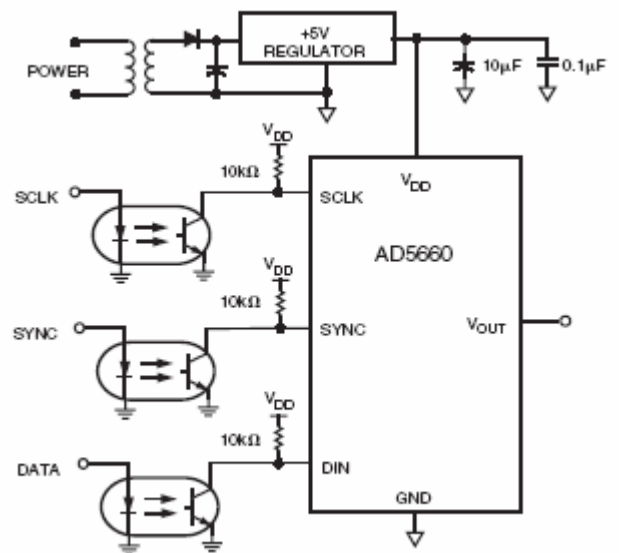

Figure 33. AD5660 with an Opto-Isolated Interface

POWER SUPPLY BYPASSING AND GROUNDING

When accuracy is important in a circuit it is helpful to carefully consider the power supply and ground return layout on the board. The printed circuit board containing the AD5660 should have separate analog and digital sections, each having its own area of the board. If the AD5660 is in a system where other devices require an AGND to DGND connection, the connection should be made at one point only. This ground point should be as close as possible to the AD5660.

The power supply to the AD5660 should be bypassed with 10 μF and 0.1 μF capacitors. The capacitors should be physically as close as possible to the device with the 0.1 μF capacitor ideally right up against the device. The 10 μF capacitors are the tantalum bead type. It is important that the 0.1 μF capacitor has low effective series resistance (ESR) and effective series inductance (ESL), for example, common ceramic types of

capacitors. This 0.1 μF capacitor provides a low impedance path to ground for high frequencies caused by transient currents due to internal logic switching.

The power supply line itself should have as large a trace as possible to provide a low impedance path and reduce glitch effects on the supply line. Clocks and other fast switching digital signals should be shielded from other parts of the board by digital ground. Avoid crossover of digital and analog signals if possible. When traces cross on opposite sides of the board, ensure that they run at right angles to each other to reduce feedthrough effects through the board. The best board layout technique is the microstrip technique where the component side of the board is dedicated to the ground plane only and the signal traces are placed on the solder side. However, this is not always possible with a 2-layer board.

OUTLINE DIMENSIONS

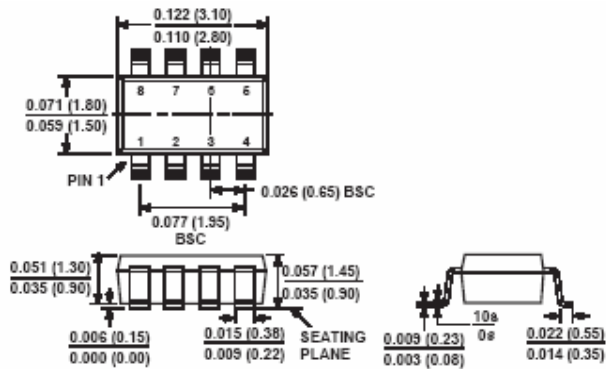

Figure 34. 8-Lead SOT-23 (RJ-8)

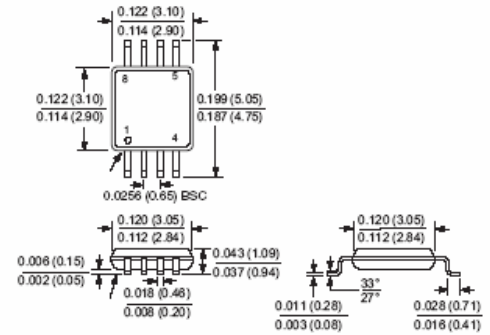

Figure 35. 8-Lead MSOP (RJ-8)

ORDERING GUIDE

Model	Grade	Power-On-Reset to	Internal Reference	Branding	Package Options ¹	Description
AD5660ARJ-1	A	Zero	1.25 V	TBD	RJ-8	±32 LSB INL, 25 ppm/°C Ref, 3 V
AD5660ARJ-2	A	Zero	2.5 V	TBD	RJ-8	±32 LSB INL, 25 ppm/°C Ref, 5 V
AD5660ARJ-3	A	Midscale	2.5 V	TBD	RJ-8	±32 LSB INL, 25 ppm/°C Ref, 5 V
AD5660BRJ-1	B	Zero	1.25 V	TBD	RJ-8	±16 LSB INL, 25 ppm/°C Ref, 3 V
AD5660BRJ-2	B	Zero	2.5 V	TBD	RJ-8	±16 LSB INL, 25 ppm/°C Ref, 5 V
AD5660BRJ-3	B	Midscale	2.5 V	TBD	RJ-8	±16 LSB INL, 25 ppm/°C Ref, 5 V
AD5660CRM-1	C	Zero	1.25 V	TBD	RM-8	±16 LSB INL, 10 ppm/°C Ref, 3 V
AD5660CRM-2	C	Zero	2.5 V	TBD	RM-8	±16 LSB INL, 10 ppm/°C Ref, 5 V
AD5660CRM-3	C	Midscale	2.5 V	TBD	RM-8	±16 LSB INL, 10 ppm/°C Ref, 5 V

¹ RJ = SOT-23
RM = MSOP

NOTES